

**RANSOME**  
MANUFACTURING

PAM Series  
Direct-Fired  
LP-Gas  
Vaporizer-Mixers

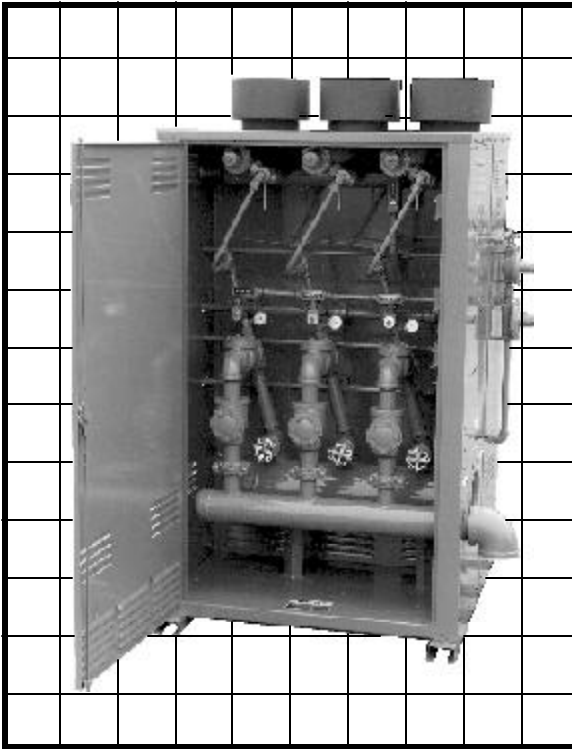



**Factory  
Mutual  
System**

## The PAM Series Vaporizer-Mixers

---

PAM Series Direct-Fired Vaporizer-Mixers provide an economical, dependable source of propane-air mixture to replace natural gas for any industrial or commercial use up to 73,500 SCFH at as high as 30 PSI.

Applications include factories, hospitals, schools, office buildings, small utilities and many others. They are individually factory-tested and calibrated on propane and shipped ready for use.

### Why a Mixer?

---

LP-Gas is a highly concentrated source of energy, with 2516 BTU's per cubic foot gross heat content. It is too rich to use as a substitute for natural gas without dilution. The Ransome mixer blends in just the right amount of air for an equivalent mixture. A mixture with specific gravity of 1.31 (1480 BTU/Cu. Ft.) will approximately match 0.6 specific gravity natural gas with 1000 BTU/Cu. Ft. gross heat content.

### Features

---

1. Exclusive Ransome Gasonic venturis maintain close control of air-gas mixture.
2. Safety shutdown interlocks protect installation from damage or hazard due to excessive or insufficient temperatures and pressures. Complete complement of safety shutdown interlocks is provided with standard models including: high propane vapor pressure; low propane vapor pressure; high mixed gas pressure; low mixed gas pressure; high vaporizer temperature; low mixed gas temperature.
3. Simple, safe electrical control system, properly grounded and fused, for long, dependable service life.
4. Dual air valves on each venturi prevent leakage of mixed gas into air inlet system.
5. Multiple venturis provide quieter operation, with much smaller surge tanks than larger, single venturi systems.
6. Gas-Air mixture is adjustable over a wide range to match natural gases with different specific gravities and heat contents.
7. Same dependable, compact, multiple-tube vaporizer construction as used in RH Series.
8. Each machine is tested and calibrated on propane under field conditions. Certified Test Data Report is provided.
9. Modular design provides maximum capacity in a compact, rectangular unit. Nearly 74,000 SCFH natural gas can be replaced by a single PAM 1000-50 occupying less than 24 square feet.
10. Models are available in a complete range of sizes from 10,000 to 50,000 SCFH mixed gas, eliminating the need to buy more capacity than required.
11. All sizes are capable of infinite turndown and will maintain a ready supply of mixed gas from zero load to full capacity. At zero load, only enough heat will be generated to maintain temperature and prevent condensation.

**PAM 400-20, PAM 600-30, PAM 800-40, PAM 1000-50**

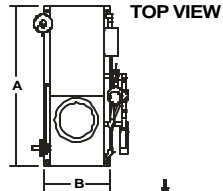
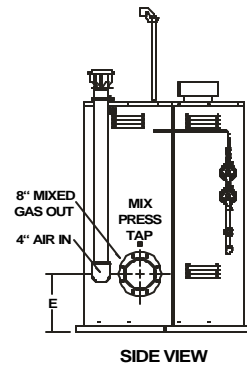
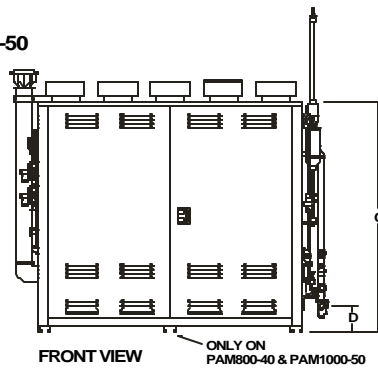
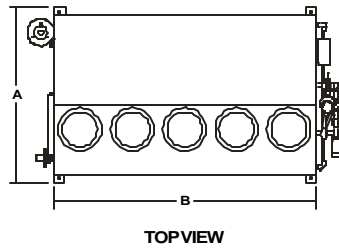

**PAM 200-10**

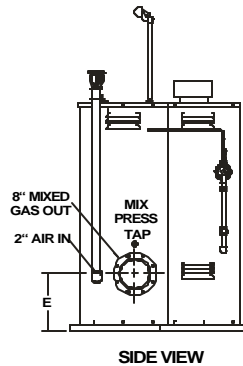
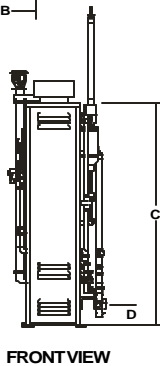

MODEL	DIMENSIONS, IN.					Weight (lb)
	A	B	C	D	E	
PAM200-10	47.25	14	67.5	8	17.5	1450
PAM400-20	53.5	28	69.5	8	17.5	2125
PAM600-30	53.5	42	69.5	8	17.5	2760
PAM800-40	53.5	56	69.5	8	17.5	3400
PAM1000-50	53.5	70	69.5	8	17.5	4400

MODEL	DIMENSIONS, CM.					Weight (kg)
	A	B	C	D	E	
PAM200-10	120	36	171	20	44	658
PAM400-20	136	71	177	20	44	964
PAM600-30	136	107	177	20	44	1252
PAM800-40	136	142	177	20	44	1542
PAM1000-50	136	178	177	20	44	1996

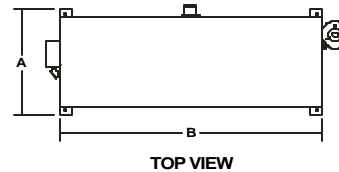

- M 10**
- M 20**
- M 30**
- M 40**
- M 50**

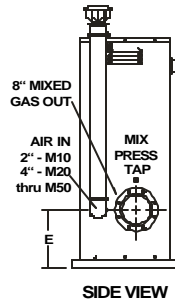
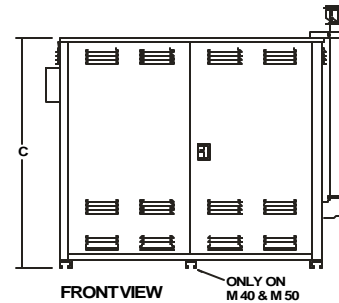

MODEL	DIMENSIONS, IN.					Weight (lb)
	A	B	C	D	E	
M10	16.5	14	67.5	62	17.5	600
M20	32	28	69.5	64	17.5	810
M30	32	42	69.5	64	17.5	1020
M40	32	56	69.5	64	17.5	1288
M50	32	70	69.5	64	17.5	1540

MODEL	DIMENSIONS, CM.					Weight (kg)
	A	B	C	D	E	
M10	42	36	171	157	44	272
M20	81	71	177	163	44	376
M30	81	107	177	163	44	463
M40	81	142	177	163	44	581
M50	81	178	177	163	44	699

**Features**

1. Place unit on a simple concrete pad.
2. Provide adequate supply of propane liquid to vaporizer inlet. Minimum inlet pressure as shown on chart below must be maintained. Use pressurizing pump as necessary.
3. Provide Ransome Model No. ST750 or other suitable 100 cubic ft. surge tank (750 gal. minimum capacity).
4. Connected mixed gas outlet of PAM or M Series to surge tank with 8" 150# flange sch. 40 spool. (5' length needed in California only).
5. Provide 110V AC, 60 Hz, 1 ph control power supply.
6. Provide piping from surge tank to natural gas line tie-in.

Mixed Gas Pressure	5	6	7	8	9	10-30 (Air Boosted)
Required Minimum Inlet Pressure PSIG	90	100	120	135	140	100

## Selection Chart

If your Peak Load Requirments are up to (1)			Ransome Model		Air Required SCFM (for 10-30 PSI Only)	Vaporization Capacity Required (for M Series Only) GPH Propane
Millions of BTU/HR	Thousands of SCFH Natural Gas (2)	Thousands of SCFH Mixed Gas (3)	Vaporizer Mixer	Mixer Only		
14.75	14.75	10	<b>PAM200-10</b>	<b>M10</b>	75	180
29.50	29.50	20	<b>PAM400-20</b>	<b>M20</b>	150	360
44.25	44.25	30	<b>PAM600-30</b>	<b>M30</b>	225	540
59.00	59.00	40	<b>PAM800-40</b>	<b>M40</b>	300	720
73.75	73.75	50	<b>PAM1000-50</b>	<b>M50</b>	375	900

## Selection Chart - SI Conversion

If your Peak Load Requirments are up to (1)			Ransome Model		Air Required M3/M (for 10-30 PSI Only)	Vaporization Capacity Required (for M Series Only) KG/HR
M KAL/HR	M3/HR Natural Gas (2)	M3/HR Mixed Gas (3)	Vaporizer Mixer	Mixer Only		
3.72	413	280	<b>PAM200-10</b>	<b>M10</b>	2.1	681.3
7.43	826	560	<b>PAM400-20</b>	<b>M20</b>	4.2	1362.6
11.15	1239	840	<b>PAM600-30</b>	<b>M30</b>	6.3	2043.9
14.87	1652	1120	<b>PAM800-40</b>	<b>M40</b>	8.4	2725.2
18.59	2065	1400	<b>PAM1000-50</b>	<b>M50</b>	10.5	3406.5

(1) Units may be parralleled to achieve greater capacities. (2) Natural Gas; S.G.U. = .6 Gross Heat Content 1000 BTU/Cu. Ft.  
 (3) Mixed Gas; Propane-Air, S.G.U. = Gross Heat Content 1480 BTU/Cu. Ft.

## Standard Specifications

Standard units are venturi-type, built in accordance with Factory Mutual. **SPECIFY DESIRED SETTING.** Factory tested and calibrated to deliver 1.31 specific gravity(1480 BTU/Cu. Ft.) **propane**-air mix. Other Gases can be utilized such as butane, butane-propane mixes, natural gas, etc. Consult the factory for their application. 110V AC, 1PH control voltage standard; other voltages available on request.

## Selection Chart

Option	Description	Add Suffix
High Pressure (10-30 PSI) Using Blower	Units require clean, dry air at constant pressure approximately 2 PSI less than that of mixed gas. Specify desired mixed gas pressure.	HB
High Pressure (10-30 PSI) Using Plant Air or Compressor	Units require clean, dry air at a minimum pressure of 2 PSI over mixed gas pressure. Specify desired mixed gas pressure.	HP
Electric Pilot Reignitor	Protects against pilot outage caused by unusually turbulent winds, and eliminates need for matches to start vaporizer. 110V required.	E
Outage Panel	Provides key start, and tells cause of safety shutdown, to simplify service. Includes alarm lights for high and low propane and mixed gas pressures, high and low air pressures (HB and HP models), high vapor and low mixed gas temperatures, a warning light for pilot outage and alarm acknowledge switch.	C
Inlet Air Filter	For all PAM and M Series machines to 10 PSI. Includes washable dry filter with housing and weather cap, mounting bracket and piping.	F

## Warranty

Ransome Manufacturing, 3495 South Maple Avenue, Fresno, California, warrants to all parties all equipment manufactured and sold by it to be free from defects in material or workmanship under normal use and service. when installed and used in accordance with all applicable state and local codes, regulations and laws or in accotdance with National Fire Protection Pamphlet 58. Ransome Manufacturing agrees to repair or replace any equipment which its examination reveals to have been defective due to faulty workmanship or material, if returned to factory, transportation charges prepaid. Deviations from recomended applications, system design, installation and service practices, as well as deterioration or wear due to foreign materials or contamination present in LP-Gas or air shall be considered as abuse and render this warranty void.

This warranty applies for a period of one year from date of installation, but not more than eighteen months after shipment from factory.

This warranty is expressly in lieu of all other warranties expressed or implied, and of all obligations or liabilities on its part for damages including but not limited to consequential damages, following the use or misuse of equipment sold by it. No agent is authorized to assume any liability for Ransome Manufacturing, except as set forth above.

